

# Software Requirements Specification (SRS)

## Project TJA3

**Authors: Abhinay Devapatla, Gram Boyle, Muxing Dai, Eric Gabbard, Matthew Crandall**

**Customer: William Milam**

**Instructor: Dr. Betty Cheng**

### 1 Introduction

The Traffic Jam Assist (TJA) system is based on the Adaptive Cruise Control (ACC) system and expands on the ACC system to reduce the number of driver errors in traffic due to fatigue. This Software Requirements Specification (SRS) document outlines the requirements and functionality of the TJA system in depth.

#### 1.1 Purpose

The purpose of an SRS document is to allow the customer to see the team's interpretation of the product and their approach to developing the desired product. This SRS document provides many diagrams that illustrate how the TJA system is intended to work. Specifically, this SRS document contains a domain model, use case diagram, sequence diagram, and a state diagram to allow the reader to become immersed in understanding the TJA system. This document is intended for stakeholders, such as the customer and developers, to understand all of the components of the TJA system.

#### 1.2 Scope

The TJA system is available to allow the vehicle to perform autonomous operations on limited access highways with slow and stopped traffic. This system expands on the existing features of the ACC system with modifications for limited access highways. When the TJA system is active, it will adjust to the traffic flow by following the vehicle in front of the driver at a set distance and continuously calculated closing rate. The TJA system is intended to be a forward moving system that helps drivers navigate during traffic on highways.

#### 1.3 Definitions, acronyms, and abbreviations

- **SRS:** Software Requirements Specification, a document that describes the expected behavior of a software system.
- **TJA:** Traffic Jam Assist, the system this SRS document focuses on.
- **ACC:** Adaptive Cruise Control, the system the TJA system is based on.
- **GPS:** Global Positioning System.
- **GNSS:** Global Navigation Satellite System, a satellite system that provides positioning.

#### 1.4 Organization

The rest of the document is organized in a way to allow optimal understanding of the TJA system. Section 2 will describe and provide all of the appropriate details related to the system.

Section 2 will enumerate all of the requirements and global invariants. Section 4 illustrates multiple diagrams to effectively model the system. Section 5 includes a proof of concept to show a visual demonstration of how the system will behave.

## **2 Overall Description**

The following sections will give an overview of the TJA system. Section 2.1 will give more context to the TJA system and describe any constraints. Section 2.2 will establish the major goals and objectives of the software. Section 2.3 will discuss what traits a user must possess in order to use this system. Section 2.4 will mention all of the safety-critical properties and their associated constraints. Section 2.5 will go over all of the assumptions and dependencies of the system. Section 2.6 will explain functionality that is outside the scope of this system at this time.

### **2.1 Product Perspective**

The TJA system is a specialized system that works exclusively on highways with traffic. The TJA system adds additional features to the existing ACC system. The system interfaces directly into the vehicle's dashboard. The driver will know whether the TJA system is active via the dashboard. The driver can interact with the system via the "resume" and "cancel" buttons located on the steering wheel. Otherwise, the TJA system will activate on limited access highways with traffic and de-activate once the highway no longer has traffic, or if the vehicle is no longer on the highway. The hardware required includes a forward-looking radar and a forward-looking camera system. The software will be added onto the existing ACC system code and only be engaged when the criteria described above are met. Additionally, the TJA system is only a forward moving system. The TJA system will not be active during operations such as lane changing or reversing. Additionally, the TJA system cannot perform computational expensive operations due to the drastic power requirements that could result.

### **2.2 Product Functions**

The TJA system will activate once the GPS system has determined that the vehicle is on a limited access highway with slow moving traffic. The system will proceed to use the forward-looking radar to identify a target vehicle directly in front of the driver's vehicle. Once the target vehicle has been identified, the TJA system will maintain a set distance, which the driver has three options to select from, and will control the closing rate to the target vehicle. If the target vehicle starts coming to a stop, the TJA system will slow down the driver's vehicle and bring it to a stop as well. When the target vehicle starts moving again, the TJA system will start moving the driver's vehicle while maintaining a set distance and controlling the closing rate. The driver has the ability to completely turn off the TJA system via the "cancel" button or allow the TJA system to re-activate via the "resume" button. Once the GPS system determines there is no longer any traffic or the vehicle is no longer on a limited access highway, the TJA system will shut down and the driver will get an alert on the dashboard.

### **2.3 User Characteristics**

The driver is expected to have legally obtained a driver's license and be considered fit to drive. The driver is expected to be attentively watching the road as the TJA system is active. The TJA

system is a partial autonomous system, not a full autonomous system, so the driver is expected to react to behaviors outside of the scope of the system, such as the target vehicle reversing. Additionally, the driver must be able to process and comprehend dashboard messages, know how to turn on and off the system, and know how to override the system if needed. The driver must have knowledge of how the ACC system works and how to operate the additional features of the TJA system.

## **2.4 Constraints**

As mentioned above, the TJA system is a forward moving system, so the system is constrained to only forward moving operations. Operations such as lane changing fall outside the scope of this system and become the user's duty to perform. A safety-critical property of the system is having a functional forward-looking radar and forward-looking camera. The radar is crucial in detecting a target vehicle, distance to the target vehicle, and the speed of the target vehicle, making it a vital component of the TJA system. If the radar becomes blocked or is faulty, the TJA system will disengage and give control back to the user. Another safety-critical property is the actuators in the vehicle controlling the autonomous operations. If the actuators are faulty or not working as intended, the TJA system must disengage and give control back to the user. The TJA system is not intended to work in hazardous weather conditions. The system constantly checks the tires, and if a slip condition is noticed, the system will entirely shut down. If the driver taps the brakes, the TJA system will disengage, and control is given to the user. It becomes the driver's duty from that moment onwards to perform the necessary operations. Lastly, if the driver taps the accelerator, the TJA system will disengage until the driver takes their foot off the gas. Essentially, if the driver touches the gas or brake pedal, the system will no longer be engaged.

## **2.5 Assumptions and Dependencies**

A major underlying assumption is that the TJA system will be equipped to a car with a state-of-the-art ACC system. The TJA system is based off of the ACC system; therefore, it can only be used in vehicles that already have an ACC system. Additionally, it is assumed that the ACC system comes with a forward-looking radar and a forward-looking camera. It is assumed that the TJA system will only activate on limited access highways with traffic. Lastly, it is assumed that the TJA system only engages if all of the components, radars, and cameras are functioning as intended.

## **2.6 A proportioning of Requirements**

The TJA system will not take weather into consideration when determining what speed to set for the driver's vehicle. For example, if the roads are covered in sleet and ice, the TJA system will not reduce the vehicle speed by half to adjust for this. The TJA system will base its speed off of the target vehicle and only adjust its speed to the actions of the target vehicle. Additionally, lane changing is out of the scope of the TJA system. If the user decides to merge lanes, the TJA system will disengage and reengage once the lane changing has been complete.

## **3 Specific Requirements**

This section provides a hierarchical enumeration of the requirements of the system. These requirements include software, hardware, and safety requirements of the system.

1. The Traffic Jam Assist (TJA) system must be based on the Adaptive Cruise Control (ACC) system.
  - 1.1. The TJA system, like the ACC system, uses a forward-looking radar to identify a target vehicle and to determine the closing rate to the target vehicle, which ideally should be zero.
    - 1.1.1. If the closing rate is positive, it means that the closing distance between the driver's vehicle and target vehicle is growing, and no action is needed.
    - 1.1.2. If the closing rate is negative, it means that the closing distance between the driver's vehicle and target vehicle is decreasing, and the driver's vehicle needs to slow down and maintain a set distance.
      - 1.1.2.1. The driver must have 3 selections for the set distance: 1 car length distance (default), 2 car length distance, or 3 car length distance.
  - 1.2. The TJA system, like the ACC system, uses a forward-looking camera to allow lane following that keeps the vehicle in the middle of the lane it is in.
  - 1.3. The TJA system's lane following feature, like the ACC system, will steer the vehicle back into its current lane if the driver attempts to change lanes without signaling.
    - 1.3.1. The turn signal will disable the lane following system to allow the driver to successfully merge into another lane.
2. The TJA system will add autonomous operations to adjust to traffic flow by following or stopping behind a target vehicle in the case of slow and stopped traffic on limited access highways.
  - 2.1. If the target vehicle is not moving, the TJA system will stop the driver's vehicle a set distance behind the target vehicle. Specifically, the driver's vehicle must slow down and maintain a reasonable distance that allows the driver to see the rear tires of the target vehicle (default is 1 car length).
  - 2.2. If the target vehicle is moving, the TJA system will start the driver's vehicle and follow the target vehicle at a set distance and control the closing rate. Specifically, the vehicle must follow at a set distance (default is 1 car length) and continuously recalculate the closing rate.
3. The purpose of the TJA system is to reduce driver errors due to fatigue since the driver will no longer have to go between the accelerator and the brakes in traffic. The more often a driver does this, the more often they will make a mistake.
4. The TJA system should only be activated when the GPS tracking device indicates that the vehicle is on a limited access highway and that there is traffic on the highway.
  - 4.1. The GPS tracking device must be able to communicate with the Global Navigation Satellite System (GNSS) network [1, pp. 2] to retrieve information from the GNSS network about the vehicle's current location and traffic on the road.
5. The TJA system will alert the driver of warnings when the closing distance is negative, the vehicle speed is too high, or the vehicle is not lane following.
  - 5.1. The TJA system will display warnings on the dashboard.

- 5.2. The TJA system will have an auditory warning system consisting of beeps.
6. The TJA system is purely a forward moving system.
  - 6.1. The TJA system will not be active during lane changing.
    - 6.1.1. After lane changing, the TJA system will resume at that set speed if there are no new target vehicles.
    - 6.1.2. After lane changing, the TJA system will recalculate the set speed and closing distance after identifying a new target vehicle.
  - 6.2. If the target vehicle starts reversing, it falls outside the scope of the TJA system and becomes the driver's duty to make the appropriate action.
  - 6.3. If there are inclement weather conditions, it falls outside the scope of the TJA system and becomes the driver's duty to make the appropriate action.
7. If the TJA system needs to disengage, it will inform the driver on the dashboard and deactivate.
  - 7.1. The TJA system will disengage if the radar sensor is faulty or blocked.
  - 7.2. The TJA system will disengage if the system detects a slip condition.
    - 7.2.1. A slip condition is when the wheels are not going the same.
8. The driver will have control over the TJA system.
  - 8.1. If the driver taps the brakes, the ACC system will disable, and as such, the TJA system.
  - 8.2. If the driver accelerates, the TJA system will allow them to, but after they take their foot off the accelerator, the system returns to the set speed.
  - 8.3. The driver must be attentively paying attention to the road.
    - 8.3.1. Tactile feedback on the steering wheel will determine if the driver is attentive.
    - 8.3.2. A driver-facing infrared camera will determine if the driver is attentive.
9. The steering wheel will have buttons to "resume" or "cancel" the TJA system.
  - 9.1. The resume button will bring the vehicle back to its previous set speed.
  - 9.2. The cancel button will turn the system off, including the ability to resume.
10. The TJA system is meant for highways without lots of hills and tunnels and inclement weather conditions, since it affects the radar, camera, and lane keeping.

### **3.1 Global Invariants**

1. The vehicle shall not exceed 10 mph if a target vehicle is detected within 15 feet.
2. The vehicle shall maintain a distance of at least 1 car length to the target vehicle.
3. The vehicle shall never surpass 80 mph.
4. The driver shall be able to select a set distance.
5. The TJA system is only a forward moving system.

## **4 Modeling Requirements**

This section contains models that help to better illustrate and describe the TJA system. This section included a use-case diagram, domain model, sequences diagrams, and state diagrams.

### **4.1 Use Case Diagram**

The use case diagram, in **Figure 1** below, illustrates all of the use cases of the TJA system. The system boundary is represented by the rectangle, the actors are represented by the stick figures, the use cases are represented by circles, and associations between actors and use cases are represented by lines. Some use cases have a unique relationship indicated by “<include>” or “<extend>”. When use cases have a piece of behavior that is similar across them, the use cases include this common use case. When use cases are similar to other use cases, but have additional functionality, the use cases extend for the similar use case. The system boundary for this use case diagram is the TJA system.

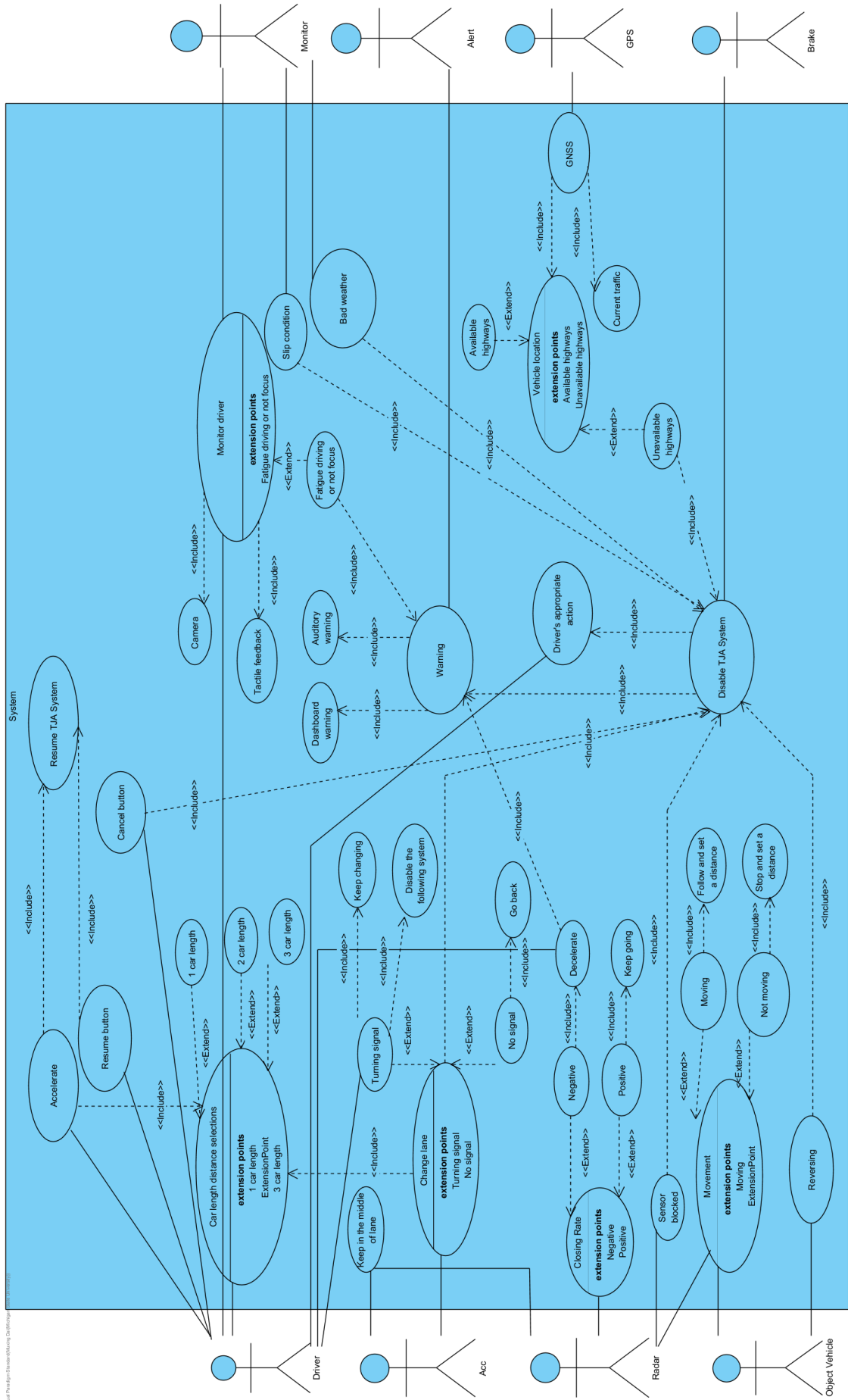

**Figure 1:** Use Case Diagram for TJA system

The tables provided below go further into detail about the use cases.

<b>Name:</b>	Positive Closing Rate
<b>Requirement ID:</b>	1.1.1
<b>Actors:</b>	Radar
<b>Description:</b>	If the closing rate is positive, it means that the closing distance between the driver's vehicle and target vehicle is growing, and no action is needed.
<b>Type:</b>	Primary
<b>Use Cases:</b>	Keep going
<b>Includes:</b>	Keep going
<b>Extends:</b>	None

<b>Name:</b>	Negative Closing Rate
<b>Requirement ID:</b>	1.1.2
<b>Actors:</b>	Radar
<b>Description:</b>	If the closing rate is negative, it means that the closing distance between the driver's vehicle and target vehicle is decreasing, and the driver's vehicle needs to slow down and maintain a set distance.
<b>Type:</b>	Primary and essential
<b>Use Cases:</b>	Decelerate
<b>Includes:</b>	Decelerate
<b>Extends:</b>	None

<b>Name:</b>	Car length distance selections
<b>Requirement ID:</b>	1.1.2.1, 6.1.1, 6.1.2
<b>Actors:</b>	Driver
<b>Description:</b>	The driver must have 3 selections for the set distance: 1 car length distance (default), 2 car length distance, or 3 car length distance.
<b>Type:</b>	Primary
<b>Use Cases:</b>	1 car length, 2 car length, 3 car length
<b>Includes:</b>	None
<b>Extends:</b>	1 car length, 2 car length, 3 car length

<b>Name:</b>	Keep in the middle of lane
<b>Requirement ID:</b>	1.2
<b>Actors:</b>	ACC



<b>Description:</b>	The TJA system, like the ACC system, uses a forward-looking camera to allow lane following that keeps the vehicle in the middle of the lane it is in.
<b>Type:</b>	Primary
<b>Use Cases:</b>	None
<b>Includes:</b>	None
<b>Extends:</b>	None

<b>Name:</b>	No signal
<b>Requirement ID:</b>	1.3
<b>Actors:</b>	ACC
<b>Description:</b>	The TJA system's lane following feature, like the ACC system, will steer the vehicle back into its current lane if the driver attempts to change lanes without signaling.
<b>Type:</b>	Primary and essential
<b>Use Cases:</b>	Go back
<b>Includes:</b>	Go back
<b>Extends:</b>	None

<b>Name:</b>	Turning signal
<b>Requirement ID:</b>	1.3.1
<b>Actors:</b>	ACC
<b>Description:</b>	The turn signal will disable the lane following system to allow the driver to successfully merge into another lane.
<b>Type:</b>	Primary and essential
<b>Use Cases:</b>	Keep changing, Disable the following system
<b>Includes:</b>	Keep changing, Disable the following system
<b>Extends:</b>	None

<b>Name:</b>	Movement
<b>Requirement ID:</b>	2
<b>Actors:</b>	Radar, Object Vehicle
<b>Description:</b>	The TJA system will add autonomous operations to adjust to traffic flow by following or stopping behind a target vehicle in the case of slow and stopped traffic on limited access highways.
<b>Type:</b>	Primary and essential
<b>Use Cases:</b>	Moving, Not moving
<b>Includes:</b>	None
<b>Extends:</b>	Moving, Not moving

<b>Name:</b>	Not moving
--------------	------------

<b>Requirement ID:</b>	2.1
<b>Actors:</b>	Radar, Object Vehicle
<b>Description:</b>	If the target vehicle is not moving, the TJA system will stop the driver's vehicle a set distance behind the target vehicle. Specifically, the driver's vehicle must slow down and maintain a reasonable distance that allows the driver to see the rear tires of the target vehicle (default is 1 car length).
<b>Type:</b>	Primary and essential
<b>Use Cases:</b>	Stop and set a distance
<b>Includes:</b>	Stop and set a distance
<b>Extends:</b>	None

<b>Name:</b>	Moving
<b>Requirement ID:</b>	2.2
<b>Actors:</b>	Radar, Object Vehicle
<b>Description:</b>	If the target vehicle is moving, the TJA system will start the driver's vehicle and follow the target vehicle at a set distance and control the closing rate. Specifically, the vehicle must follow at a set distance (default is 1 car length) and continuously recalculate the closing rate.
<b>Type:</b>	Primary and essential
<b>Use Cases:</b>	Follow and set a distance
<b>Includes:</b>	Follow and set a distance
<b>Extends:</b>	None

<b>Name:</b>	Monitor driver
<b>Requirement ID:</b>	3, 8.3, 8.3.1, 8.3.2
<b>Actors:</b>	Monitor, Driver
<b>Description:</b>	The purpose of the TJA system is to reduce driver errors due to fatigue since the driver will no longer have to go between the accelerator and the brakes in traffic. The more often a driver does this, the more often they will make a mistake. The driver must be attentively paying attention to the road. Tactile feedback on the steering wheel will determine if the driver is attentive. A driver-facing infrared camera will determine if the driver is attentive.
<b>Type:</b>	Primary
<b>Use Cases:</b>	Fatigue driving or not focus, Camera, Tactile feedback.
<b>Includes:</b>	Camera, Tactile feedback
<b>Extends:</b>	Fatigue driving or not focus

<b>Name:</b>	Available highways
--------------	--------------------

<b>Requirement ID:</b>	4, 10
<b>Actors:</b>	GPS
<b>Description:</b>	The TJA system should only be activated when the GPS tracking device indicates that the vehicle is on a limited access highway and that there is traffic on the highway.
<b>Type:</b>	Primary
<b>Use Cases:</b>	None
<b>Includes:</b>	None
<b>Extends:</b>	None

<b>Name:</b>	GNSS
<b>Requirement ID:</b>	4.1
<b>Actors:</b>	GPS
<b>Description:</b>	The GPS tracking device must be able to communicate with the Global Navigation Satellite System (GNSS) network [1, pp. 2] to retrieve information from the GNSS network about the vehicle's current location and traffic on the road.
<b>Type:</b>	Primary and essential
<b>Use Cases:</b>	Vehicle location, Current traffic
<b>Includes:</b>	Vehicle location, Current traffic
<b>Extends:</b>	None

<b>Name:</b>	Warning
<b>Requirement ID:</b>	5, 5.1, 5.2
<b>Actors:</b>	Alert
<b>Description:</b>	The TJA system will alert the driver of warnings when the closing distance is negative, the vehicle speed is too high, or the vehicle is not lane following. The TJA system will display warnings on the dashboard. The TJA system will have an auditory warning system consisting of beeps.
<b>Type:</b>	Primary and essential
<b>Use Cases:</b>	Dashboard warning, Auditory warning
<b>Includes:</b>	Dashboard warning, Auditory warning
<b>Extends:</b>	None

<b>Name:</b>	Disable TJA System
<b>Requirement ID:</b>	6, 8.1
<b>Actors:</b>	Brake
<b>Description:</b>	The TJA system is purely a forward moving system.
<b>Type:</b>	Primary and essential

<b>Use Cases:</b>	Driver's appropriate action, Warning
<b>Includes:</b>	Driver's appropriate action, Warning
<b>Extends:</b>	None

<b>Name:</b>	Change lane
<b>Requirement ID:</b>	6.1
<b>Actors:</b>	ACC
<b>Description:</b>	The TJA system will not be active during lane changing.
<b>Type:</b>	Primary and essential
<b>Use Cases:</b>	Turning signal, No signal, Disable TJA System
<b>Includes:</b>	Disable TJA System, Car length distance selections
<b>Extends:</b>	Turning signal, No signal

<b>Name:</b>	Reversing
<b>Requirement ID:</b>	6.2
<b>Actors:</b>	Object Vehicle
<b>Description:</b>	If the target vehicle starts reversing, it falls outside the scope of the TJA system and becomes the driver's duty to make the appropriate action.
<b>Type:</b>	Primary and essential
<b>Use Cases:</b>	Disable TJA System
<b>Includes:</b>	Disable TJA System
<b>Extends:</b>	None

<b>Name:</b>	Bad weather
<b>Requirement ID:</b>	6.3
<b>Actors:</b>	Monitor
<b>Description:</b>	If there are inclement weather conditions, it falls outside the scope of the TJA system and becomes the driver's duty to make the appropriate action.
<b>Type:</b>	Primary and essential
<b>Use Cases:</b>	Disable TJA System
<b>Includes:</b>	Disable TJA System
<b>Extends:</b>	None

<b>Name:</b>	Dashboard warning
<b>Requirement ID:</b>	7
<b>Actors:</b>	Alert
<b>Description:</b>	If the TJA system needs to disengage, it will inform the driver on the dashboard and deactivate.

<b>Type:</b>	Secondary and essential
<b>Use Cases:</b>	None
<b>Includes:</b>	None
<b>Extends:</b>	None

<b>Name:</b>	Sensor blocked
<b>Requirement ID:</b>	7.1
<b>Actors:</b>	Radar
<b>Description:</b>	The TJA system will disengage if the radar sensor is faulty or blocked.
<b>Type:</b>	Primary and essential
<b>Use Cases:</b>	Disable TJA System
<b>Includes:</b>	Disable TJA System
<b>Extends:</b>	None

<b>Name:</b>	Slip condition
<b>Requirement ID:</b>	7.2, 7.2.1
<b>Actors:</b>	Monitor
<b>Description:</b>	The TJA system will disengage if the system detects a slip condition. A slip condition is when the wheels are not going the same.
<b>Type:</b>	Primary and essential
<b>Use Cases:</b>	Disable TJA System
<b>Includes:</b>	Disable TJA System
<b>Extends:</b>	None

<b>Name:</b>	Accelerate
<b>Requirement ID:</b>	8, 8.2
<b>Actors:</b>	Driver
<b>Description:</b>	The driver will have control over the TJA system. If the driver accelerates, the TJA system will allow them to, but after they take their foot off the accelerator, the system returns to the set speed.
<b>Type:</b>	Primary and essential
<b>Use Cases:</b>	Resume TJA System, Car length distance selections
<b>Includes:</b>	Resume TJA System, Car length distance selections
<b>Extends:</b>	None

<b>Name:</b>	Resume button
<b>Requirement ID:</b>	9, 9.1
<b>Actors:</b>	Driver

<b>Description:</b>	The steering wheel will have buttons to “resume” or “cancel” the TJA system. The resume button will bring the vehicle back to its previous set speed.
<b>Type:</b>	Primary and essential
<b>Use Cases:</b>	Resume TJA System
<b>Includes:</b>	Resume TJA System
<b>Extends:</b>	None

<b>Name:</b>	Cancel button
<b>Requirement ID:</b>	9, 9.2
<b>Actors:</b>	Driver
<b>Description:</b>	The cancel button will turn the system off, including the ability to resume.
<b>Type:</b>	Primary and essential
<b>Use Cases:</b>	Disable TJA System
<b>Includes:</b>	Disable TJA System
<b>Extends:</b>	None

## 4.2 Domain Model

The domain model, in **Figure 2** below, illustrates all of the relationships of the TJA system. The domain model was developed using UML class diagram notation. The classes are represented by blue boxes. The top rectangle of the class is the name of the class, and the bottom rectangle contains attributes and functions. There are many types of relationships between the classes. The line between classes is an association. If there is an empty diamond on one side of the association, it is composition. If there is a filled diamond on one side of the association, it is aggregation. Finally, the association has multiple on each side, indicating a quantifiable relationship.

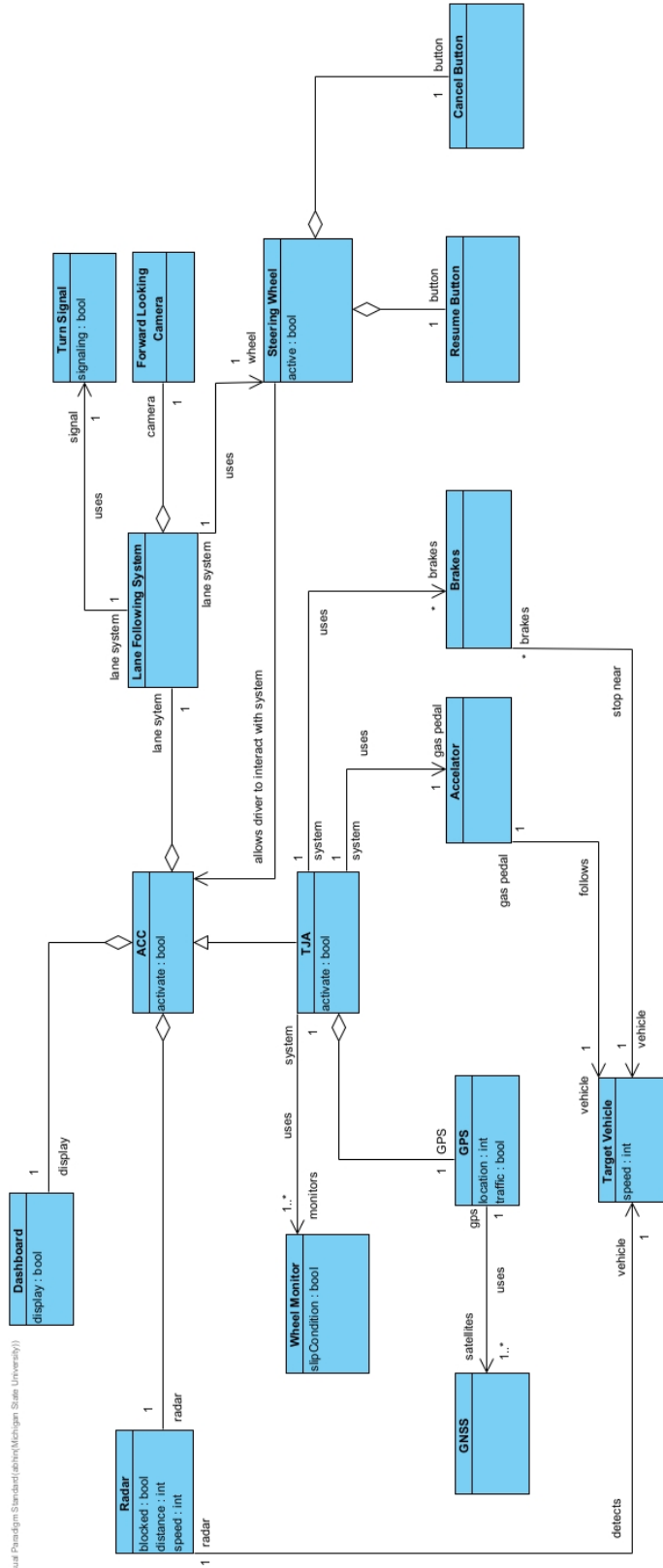

Figure 2: Domain Model for the TJA system

The data dictionary provided below goes further into detail about the domain model.

<b>Element Name</b>	<b>Description</b>
Brakes	Pressed by the operator to take control of the system. Brakes turn off the TJA system. TJA systems used the brakes when closing speed is negative.
Attributes	
Operations	TurnOffTJA()
Relationships	
	TJA. TJA uses the brakes to stop/slow the vehicle if the closing speed is negative. The Brake pedal also disengages the TJA if the driver uses it
UML Extensions	

<b>Element Name</b>	<b>Description</b>
Accelerator	Pressed by the operator if they want to accelerate. Stops the TJA system momentarily but it resumes once accelerator is released. TJA system uses the accelerator if target car is further away than the set distance.
Attributes	
Operations	TurnOffTJA() ResumeTJA()
Relationships	
	TJA. TJA uses the accelerator to speed up the vehicle if the target vehicle is more than the set distance away. Also, the accelerator pedal is pushed by the operate to disengage and resume the TJA
UML Extensions	

<b>Element Name</b>	<b>Description</b>
ACC system	This system that the TJA is derived from. The user sets a speed and distance using the dashboard and steering. Then using radars, the ACC will keep the car within that set distance from the target car.
Attributes	Activate: bool Speed: int Distance:int ClosingDistance: int
Operations	Disengage() setSpeed()



	setDistance() sendAlerts() calculateClosingDistance() turnOn() turnoff()
Relationships	Dashboard. Aggregation. Uses the dashboard to send alerts to the driver.
	Rader. Aggregation. Radar lets the ACC know whether to break or accelerate based off target vehicle.
	Lane Following System. Aggregation. The ACC uses the Lane Following system to stay within the lanes.
	Brakes Usage. Uses the brakes to maintain the set following distance
	Accelerator. Usage. Uses the accelerator to keep set following distance.
UML Extensions	

Element Name	Description
Dashboard	The dashboard is the screen located behind the steering wheel and it is used to deliver alerts and messages to the driver.
Attributes	Activated: bool
Operations	showAlert()
Relationships	ACC. Aggregation. The ACC sends alerts to the dashboard to be displayed to the driver
UML Extensions	

Element Name	Description
Radar	The radar is used to detect vehicles and objects in front of the driver's vehicle. If the radar is blocked, the ACC system should turn off
Attributes	Active: bool TargetLocation: int
Operations	sendLocation() turnOffTJA
Relationships	ACC. Aggregation. ACC uses the radar to spot objects up ahead. If a radar is blocked, the ACC should turn off.
	Target Vehicle. Usage. Uses the target vehicle to calculate the target's location.

UML Extensions	
----------------	--

Element Name	Description
Wheel Monitor	Used to check the wheels for slippage. The TJA system will turn off if slippage is detected.
Attributes	slipCondition: bool
Operations	turnoffTJA()
Relationships	TJA. Aggregation. Alerts the TJA if a slip condition is present and turns the TJA off.
UML Extensions	

Element Name	Description
Lane Following System	The lane following system uses cameras and the steering wheel to keep the car in the lane. If the cameras notice that the car is going outside marked lanes and a turn signal is not being used, the wheel will steer the car back into the lane
Attributes	Activated: bool inLane: bool turnSignalOn()
Operations	turnWheel()
Relationships	Steering Wheel. Usage. Turns the steering wheel to stay in lane.
	Turn Signal. Usage. Lane following system only uses the wheel if the turn signal is not active.
	Camera. Aggregation. Uses the camera to check if the vehicle is within the lanes.
UML Extensions	

Element Name	Description
Camera	This is the camera that is used to check the lane marking position relative to the car.
Attributes	inLane: bool
Operations	notInLane()
Relationships	Lane Following System. The camera notifies the Lane Following System if the car strays from the lane markers.
UML Extensions	

Element Name	Description
--------------	-------------

Turn Signal	The turn signal is used by the driver to warn other drivers that they are turning or changing lanes. The turn signal is also used to alert the lane following system that the car is turning intentionally, and it should not override the steering wheel.
Attributes	
Operations	alertLaneSystem()
Relationships	Lane Following System. Usage. The turn signal is used to alert the lane following system that the car is turning intentionally, and it should not override the steering wheel
UML Extensions	

Element Name	Description
Steering Wheel	Used by the driver to direct the car. The lane following system can also override the steering wheel if the car is leaving the lane.
Attributes	
Operations	setSpeed() setDistance()
Relationships	Lane Following System. Usage. IF it is determined by the Lane Following System that the vehicle is unintentionally leaving its lane, the lane following system will override the steering wheel to reposition the car.
	ACC. Usage. Allows the user to interact with the ACC. The driver sets the speed and following distance using the steering wheel
	Resume Button. Aggregation. The resume button is used to resume the ACC through the steering wheel.
	Cancel Button. Aggregation. The cancel button is used to cancel the ACC through the steering wheel.
UML Extensions	

Element Name	Description
Resume Button	Used by the driver to reactivate the ACC/TJA. Located on the steering wheel
Attributes	
Operations	ResumeTJA()

Relationships	Steering Wheel. Aggregation. The resume button is used to resume the ACC through the steering wheel.
UML Extensions	
<b>Element Name</b>	<b>Description</b>
Cancel Button	Used by the driver to cancel the ACC/TJA. Located on the steering wheel
Attributes	
Operations	CancelTJA()
Relationships	Aggregation. The resume button is used to cancel the ACC through the steering wheel.
UML Extensions	

<b>Element Name</b>	<b>Description</b>
TJA	The primary system that deviated from the ACC. Intended to help drivers in stop and go traffic. Should automatically activate when on a highway with traffic.
Attributes	Activate: bool
Operations	turnOn() turnoff()
Relationships	GPS. Aggregation. The GPS will automatically turn on the TJA system if it determined that the vehicle is on a highway with traffic.
	Wheel Monitors. Aggregation. The wheel monitors will automatically turn off the TJA is a slip condition is identified.
	Brakes Usage. The system will override the brakes if it is determined that there is a negative closing distance. Brakes also turn system off if they are activated by the user.
	Accelerator. Usage. The system will override the accelerator if it is determined that there is a positive closing distance. Accelerators also temporarily turn the system off if they are activated by the user.
UML Extensions	

<b>Element Name</b>	<b>Description</b>
GPS	The GPS is used to find the vehicle's position as well as determine if the vehicle is on a highway with traffic. If the vehicle is on a highway with traffic, the TJA will be activated
Attributes	Location: int

	Traffic: bool
Operations	activateTJA() turnOffTJA()
Relationships	TJA. Aggregation. The GPS determines if the vehicle is on a limited access highway and will turn on TJA if that is the case. It will also turn off the TJA when the car exits a traffic situation.
	GNSS. Communication. Communicates with the GNSS to determine the vehicle's location and if the vehicle is on a limited access highway.
UML Extensions	
<b>Element Name</b>	<b>Description</b>
GNSS	The Global Navigation Satellite System. Sends vehicle location and traffic information to the GPS system.
Attributes	
Operations	
Relationships	GPS. Communication. Sends vehicle location and traffic information to the GPS system.
UML Extensions	

<b>Element Name</b>	<b>Description</b>
Target Vehicle	The target vehicle determines the actions of the TJA and the user's car.
Attributes	
Operations	
Relationships	Radar. The radar locates the target vehicle and sends this information to the TJA
	Brakes. The brakes are activated based off the speed of the target vehicle
	Accelerator. The accelerator is activated based off the speed and location of the target vehicle.
UML Extensions	

### 4.3 Sequence Diagram

In this section, six sequence diagrams are illustrated to further elaborate on how specific scenarios are handled in the TJA system. The lifeline is indicated by the blue box with a line

going out of it. The messages between objects are indicated by the arrow between the dotted lines. The messages are ordered in the order they occur.

**Figure 3**, below, shows the scenario of activating the TJA system. The GPS system lets the TJA system know its current location and traffic at that location, dictating when the TJA system should activate. After activation, the TJA system turns on the forward-looking radar and determines the target vehicle in front of the driver’s vehicle.

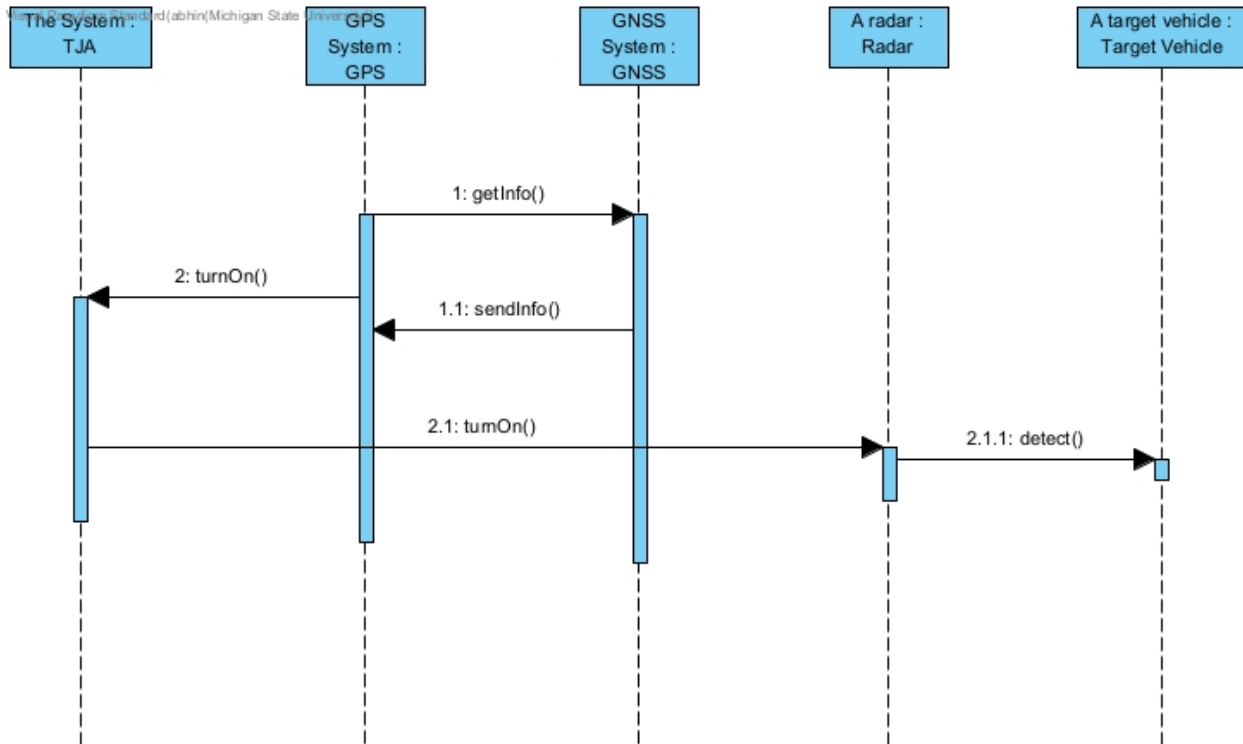

**Figure 3:** Scenario 1

**Figure 4**, below, shows the scenario of the TJA system slowing down the driver’s vehicle. The radar determines if the target vehicle is moving or not. After the radar lets the TJA system know that the target vehicle is not moving, the TJA system engages the brakes to slow down and come to a stop.

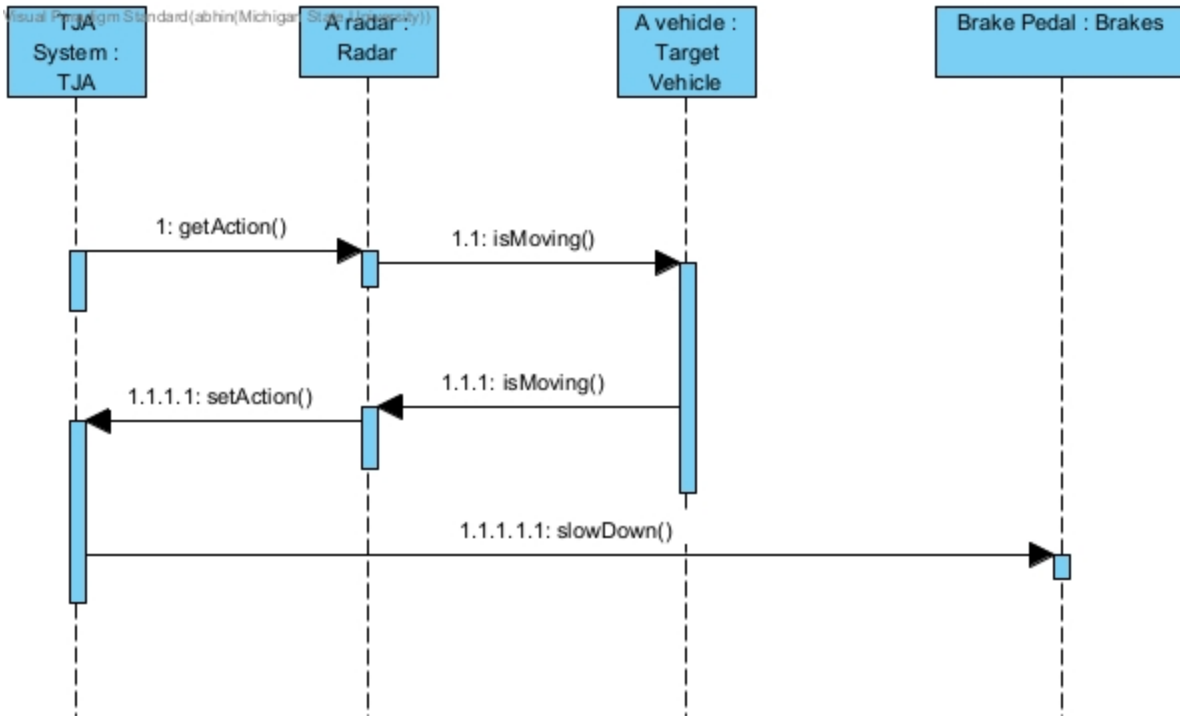

**Figure 4:** Scenario 2

**Figure 5**, below, shows the scenario of the TJA system starting up the driver’s vehicle. The radar determines if the target vehicle is moving or not. After the radar lets the TJA system know that the target vehicle is moving, the TJA system engages the accelerator to speed up and maintain a set distance to the target vehicle.

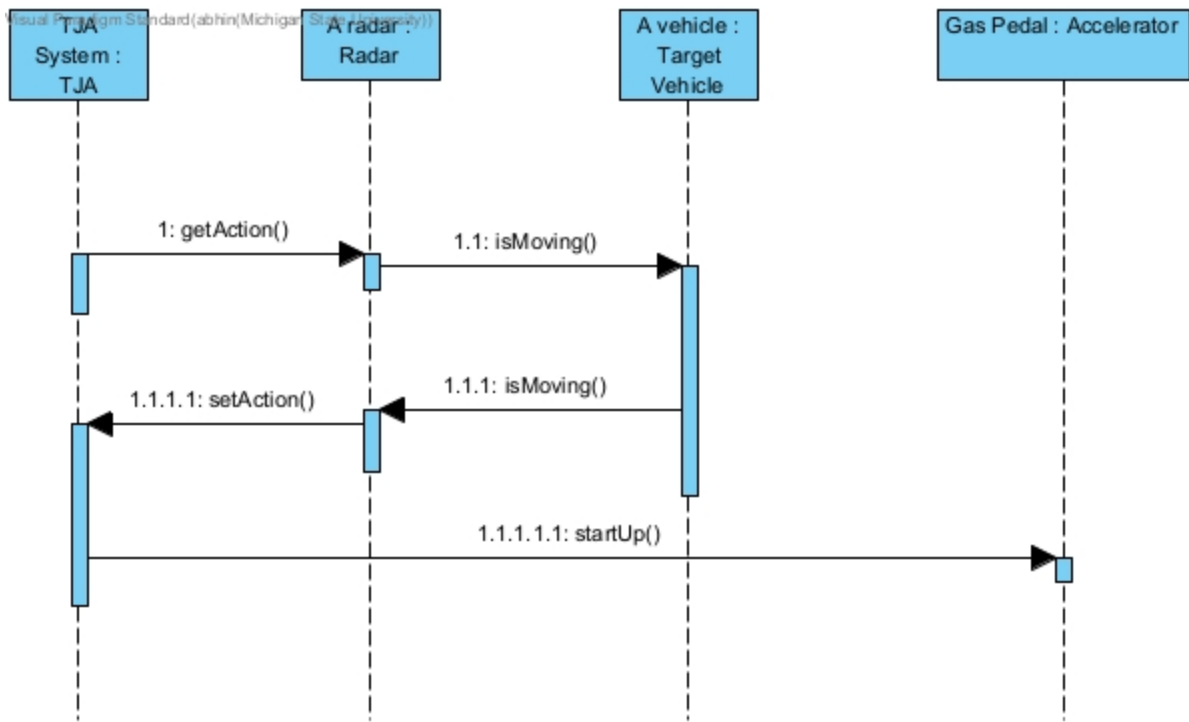

**Figure 5:** Scenario 3

**Figure 6**, below, shows the scenario of the TJA system deactivating when the driver wants to merge lanes. The lane following system will try to steer the vehicle back into the lane if the indicator is not applied. Once the indicator is applied, the lane following system will cause the TJA system to shut down because the vehicle is about to merge.

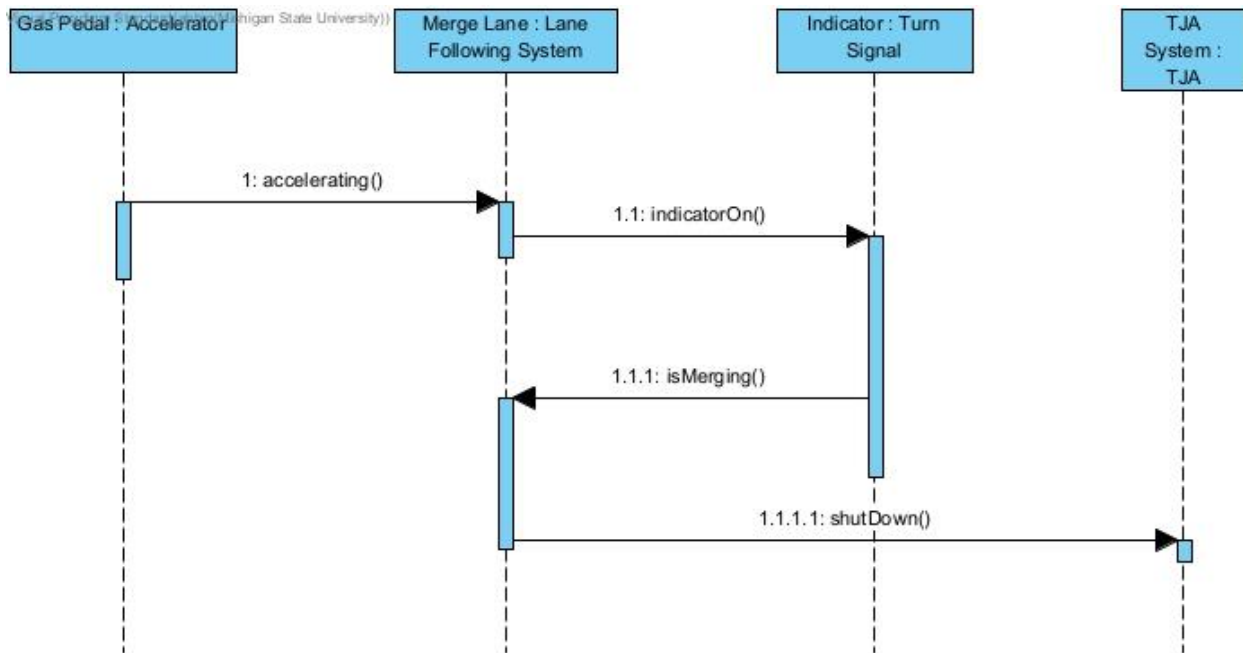



**Figure 6:** Scenario 4

**Figure 7**, below, shows the scenario of the TJA system shutting down due to a radar issue. The radar determines if the target vehicle is moving or not. If the radar is giving faulty information or is being blocked by inclement weather conditions, the TJA system will shut down.

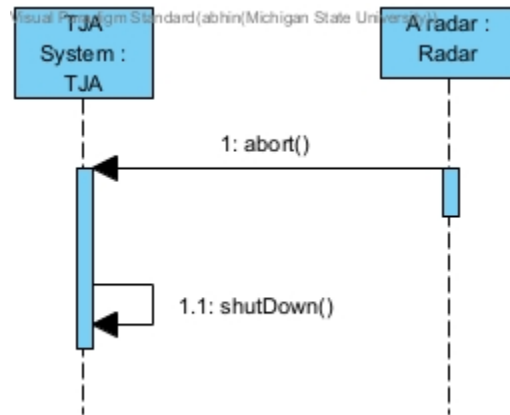

**Figure 7:** Scenario 5

**Figure 8**, below, shows the scenario of de-activating the TJA system. The GPS system lets the TJA system know its current location and traffic at that location, dictating when the TJA system should activate. If the GPS indicates that the vehicle is no longer on a limited access highway with traffic, the TJA will turn itself off.

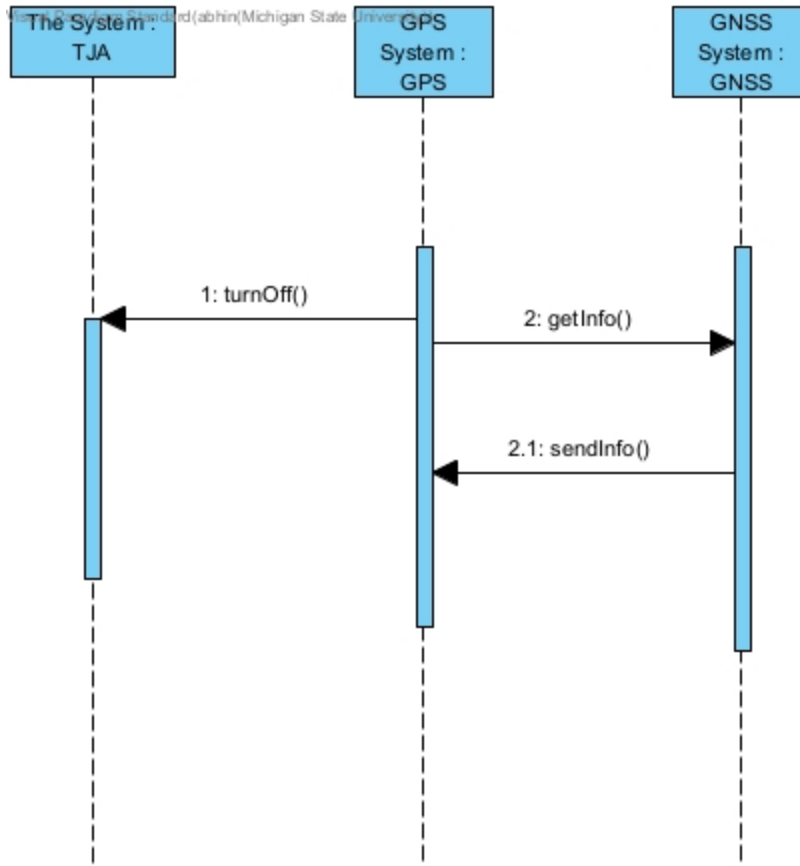
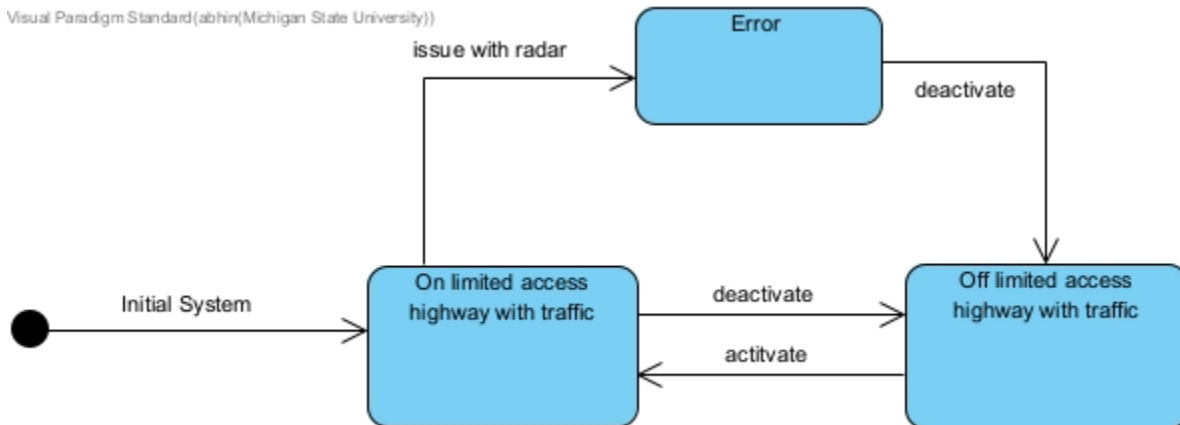

**Figure 8:** Scenario 6

#### 4.4 State Diagram

In this section, state machines are illustrated to show how states change between the different components. State machines are, in fact, another method to understand scenarios.

**Figure 9**, below, the TJA system turns on only on limited access highways with traffic and turns off when it is no longer on highways with traffic. Additionally, the TJA system will turn off if there are any issues with the radar. This state diagram references scenarios 1, 5, and 6.



**Figure 9:** State Diagram of on/off

**Figure 10**, below, the TJA system initially adjusts to the traffic flow by stopping behind the idle target vehicle. Once the target vehicle starts moving, the driver’s vehicle also starts following at a user set distance. Once the target vehicle starts coming to a stop, the driver’s vehicle also starts coming to a stop. This state diagram references scenarios 2 and 3.

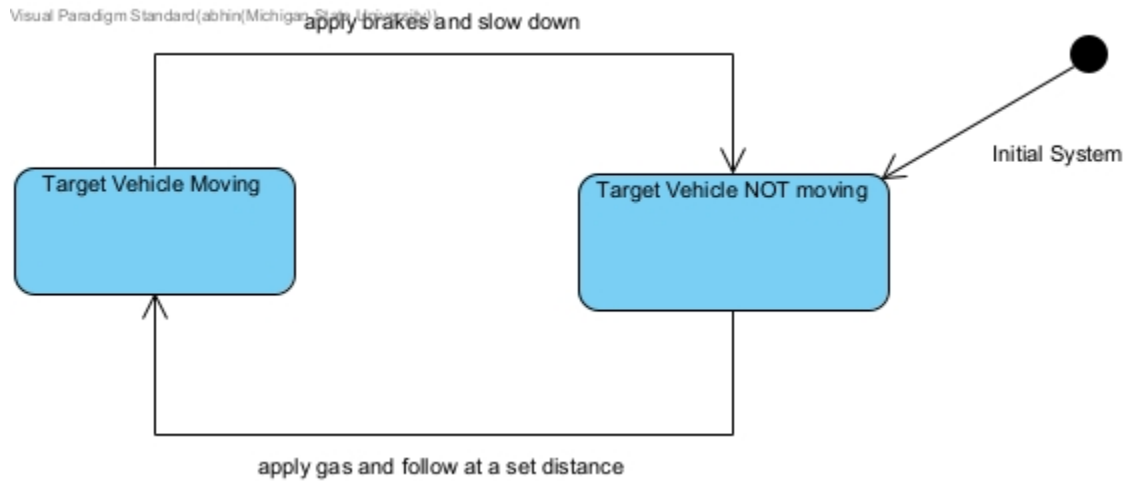

**Figure 10:** State Diagram of accelerator and brakes

**Figure 11**, below, the TJA system is initially already active. When the user decides to merge lanes by signaling, the TJA system will deactivate. When the vehicle is back in the center of its lane, the TJA system will activate. This state diagram references scenario 4.

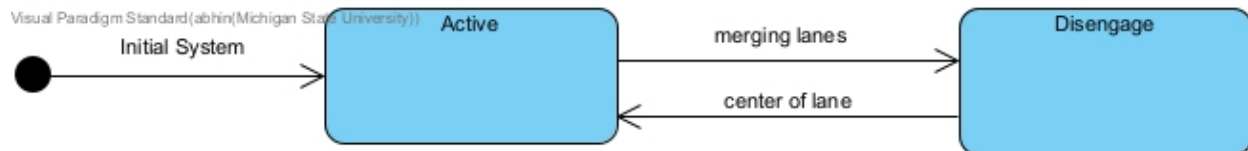

**Figure 11:** State Diagram of Lane Following

## 5 Prototype

This prototype will show how the TJA system performs in the scenarios mentioned above. The prototype will allow the reader of this document to have a visual reference to all the components of the TJA system and have a deeper understanding of the system.

### 5.1 How to Run Prototype

To access the prototype, go to <https://prototype.abhinaydevapat1.repl.co/>. The prototype is accessible via the web, so it can be run on laptop with an internet connection. The prototype will be difficult to access on smartphones, so please use a laptop. The functionality of the prototype is currently being developed. Currently, the prototype shows the result of each provided scenario.

### 5.2 Sample Scenarios

Scenario 1

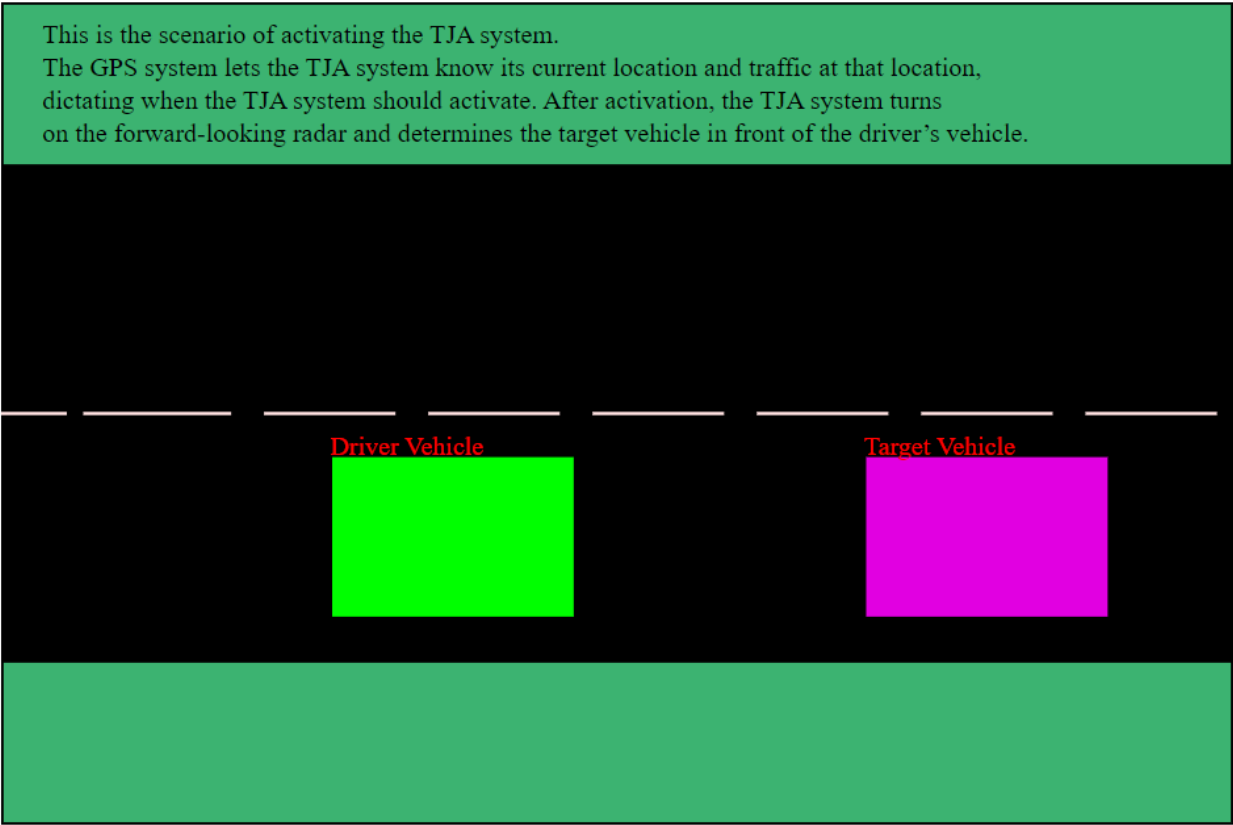
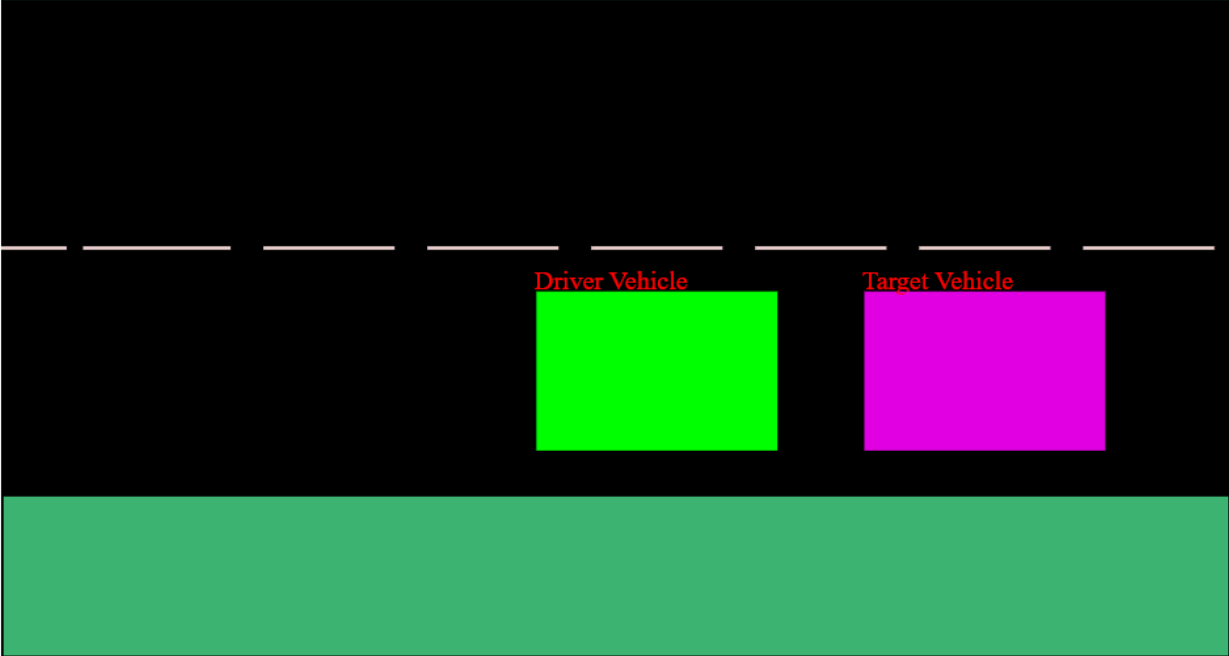

Figure 12: Sample Scenario 1 from Prototype

Scenario 2

This is the scenario of the TJA system slowing down the driver's vehicle. The radar determines if the target vehicle is moving or not. After the radar lets the TJA system know that the target vehicle is not moving, dictating when the TJA system should activate. After activation, the TJA system turns the TJA system engages the brakes to slow down and come to a stop.



The diagram illustrates a road scene with two vehicles. A red square labeled "Driver Vehicle" is positioned on the left side of the road. A blue square labeled "Target Vehicle" is positioned on the right side of the road, further ahead. The road is represented by a black surface with a white dashed line in the center. The background above the road is a light blue gradient, and the background below the road is a light green gradient.

Figure 13: Sample Scenario 2 from Prototype

### Scenario 3

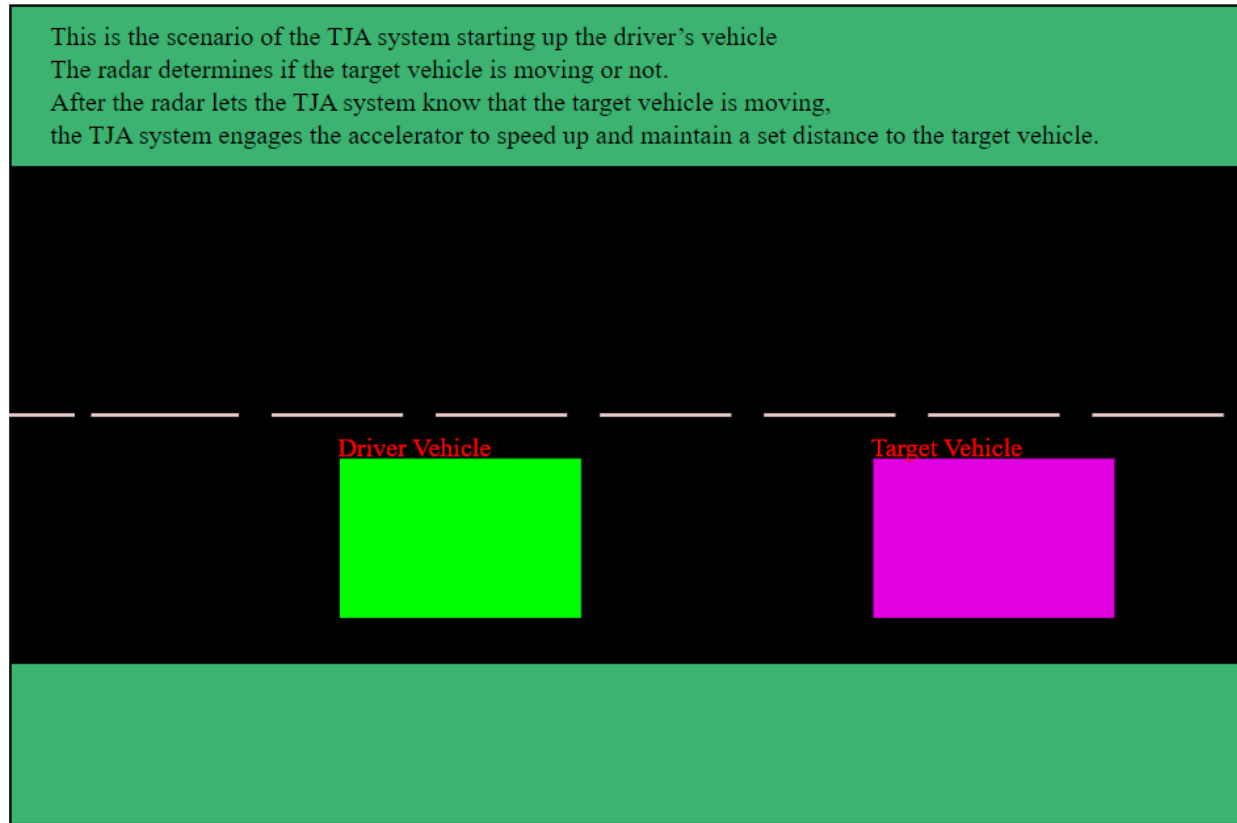

**Figure 14:** Sample Scenario 3 from Prototype

## 6 References

- [1] “What is GPS tracking and how does it work?”, mixtelematics.com. [Online]. Available: <https://www.mixtelematics.com/us/resources/blog/what-is-gps-tracking-and-how-does-it-work#:~:text=GPS%20Tracking%20System%20Basics,of%20the%20vehicle%20being%20tracked..> [Accessed Oct. 28, 2022].

## 7 Point of Contact

For further information regarding this document and project, please contact Prof. Betty H.C. Cheng at Michigan State University (chengb at msu.edu). All materials in this document have been sanitized for proprietary data. The students and the instructor gratefully acknowledge the participation of our industrial collaborators.